

BELMONDO® Kingsize Duo

<p>Prerequisites:</p> <p>Concrete area:</p> <ul style="list-style-type: none"> • Min. 10 cm thick • No holes • No ridges 		<p>Mats:</p> <p>Even temperature: min. 5°C to max. 30°C (store accordingly!)</p>			<p>i To bind liquids (urine), a small amount of absorbent bedding is always required.</p>
<p>You will need:</p>					
<p>Measuring:</p>	<p>Marking:</p>	<p>Cutting:</p>	<p>Drilling and installing:</p>	<p>KRAIBURG fixings:</p> <ul style="list-style-type: none"> • Nail plugs ø 10 x 80 mm - A2 • Washers ø 30 mm - A2 <p>With VITA Top: Spax screws ø 5 x 60 mm</p> <p>With maxiPROFIL: Framing plugs ø 10 x 100 mm</p> <p>(Fixings are part of the delivery)</p>	

Possible installation options at the edge:

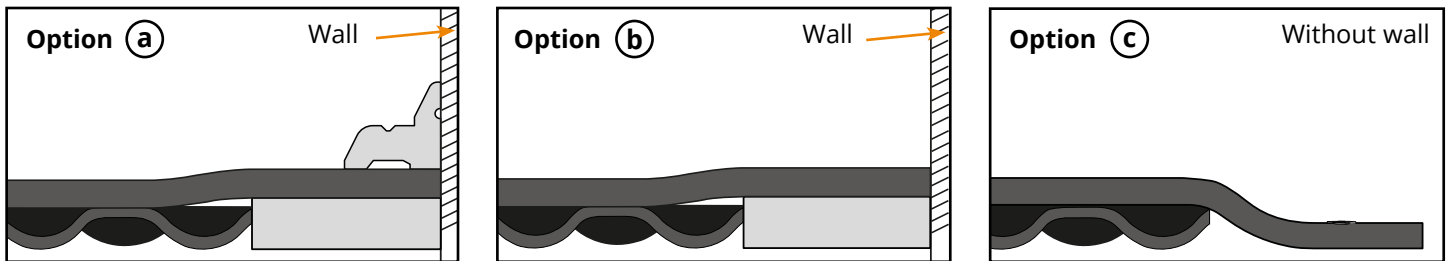

1 Install the underfloor

- 1 Fit plastic bars and fix each one twice
> **Nail plugs 10 x 80 mm**

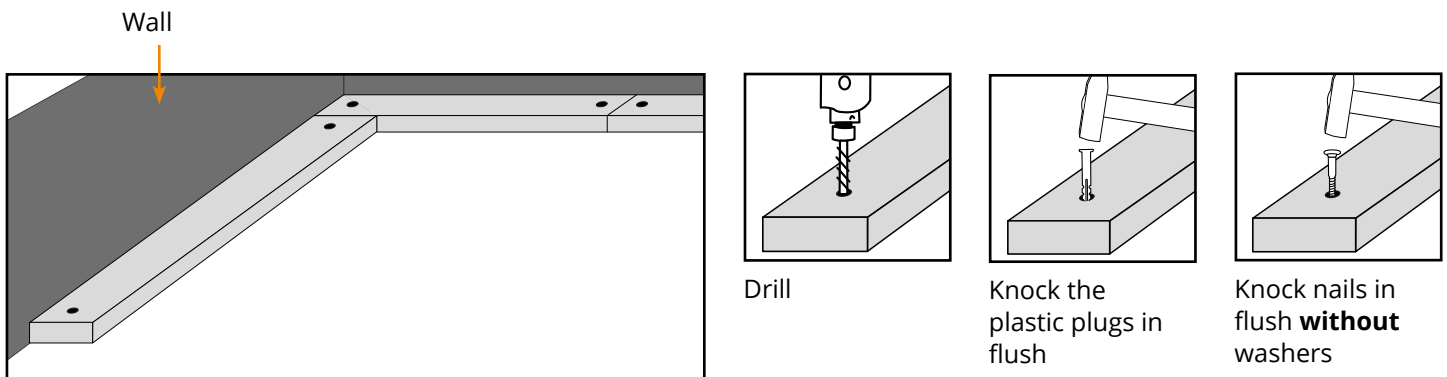

II Fit BELMONDO® Cup (lower mats)

Open cups on upper side

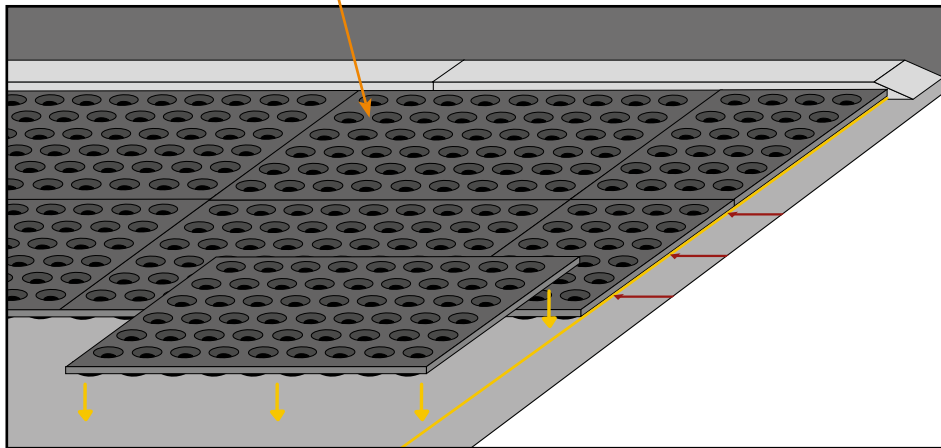

Tip:
Chamfer the plastic bar

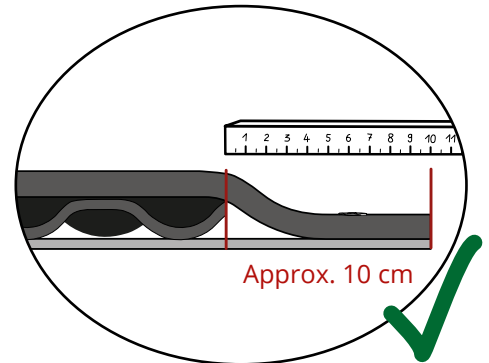

Install the lower mats jointless throughout the whole area. Without plastic bars on the sides (option **C**), place the lower mats 10 cm from the edge. If necessary, cut mats to fit.

Distance to the edge:
Approx. 10 cm

Lower mats can be installed crosswise and/or lengthwise.

2 Cut and position the BELMONDO® Kingsize Cover (top covering)

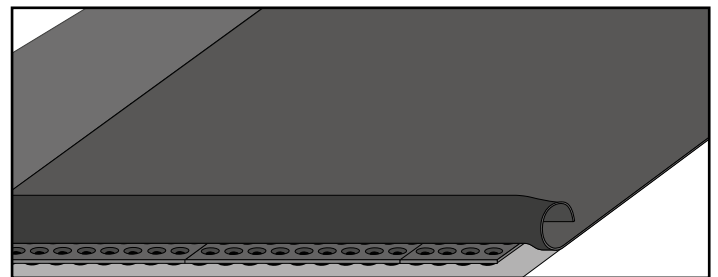
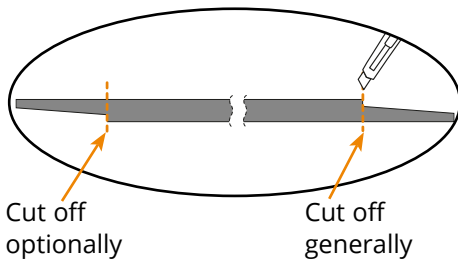
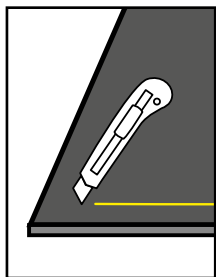

3 Fix the BELMONDO® Kingsize Cover (top covering)
> Nail plugs 10 x 80 mm

For option **a** (with covering strip): Fix every 50 cm

For option **b** + **C** (without covering strip): Fix every 20 cm

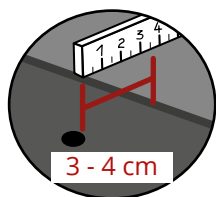

Distance to the wall: 3 - 4 cm

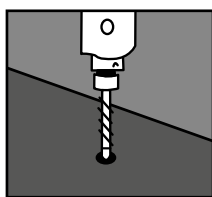

Drill

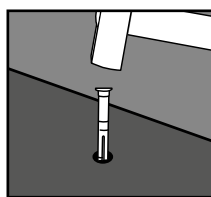

Knock the plastic plugs in flush

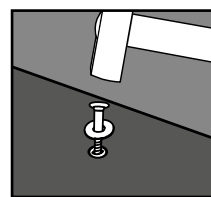

Knock in nails and washers until they are seated evenly and firmly and are slightly countersunk

Option (a) :

I Lay covering strips on the top covering along the walls

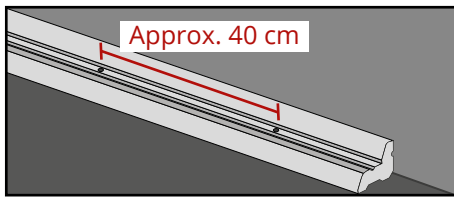

- High end at edge
- Flush to wall

II Fix every 40 cm in the position groove
> **Spax screws 5 x 60 mm**

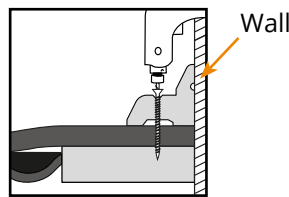

! Tighten screws until they are seated evenly and firmly.
Do not overtighten!

Optional: The joint on the back side of VITA Top can be filled with a round cord Ø 6 mm

4 At joints: Screw on maxiPROFIL

I Place connecting bars centrally on the mat joint

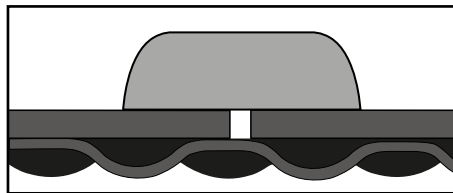
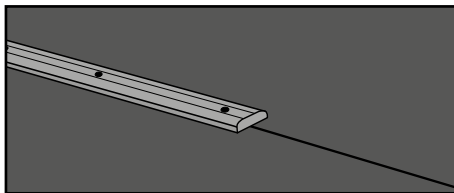

i Position of the mat joint does not depend on the position of the lower mats

II Fix maxiPROFIL
> **Framing plugs 10 x 100 mm**

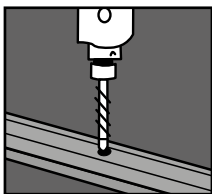

Drill

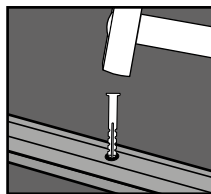

Knock the plastic plugs in flush

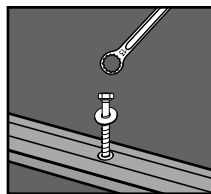

Tighten screws and washers until they are seated evenly and firmly.
Do not overtighten!

! Use every fixing hole!

i **Tip:**
Avoid bar slippage:

1. Drill the first hole
2. Install a fixing (-> fixing)
3. Then drill further holes, etc.

i Appropriate installation may differ due to local conditions. Therefore, the manufacturer shall not be liable for installation!